

VOID: SEALING FEE NOT PAID.

N° 5591



A.D. 1915

Date of Application, 14th Apr., 1915  
(Patent of Addition to No. 17,811, 28th July, 1914)  
Complete Specification Accepted, 19th Aug., 1915

COMPLETE SPECIFICATION.

System for the Generation of Electric Currents.

I, CARLOS F. BENITEZ, Civil Engineer, of 141, Ocampo Street, in Guadalajara (Mexico), do hereby declare the nature of this invention and in what manner the same is to be performed, to be particularly described and ascertained in and by the following statement:—

The invention which forms the object of this patent of addition relates to an improvement in the system for the generation of electric currents, described in the main Patent No. 17,811, filed on July 28th 1914.

The said system may be still further simplified and improved by the employment of condensers suitably placed, so as to receive separately the direct and inverse currents from the transformers, thus avoiding the use of the converters. It is true that under these conditions, with condensers of the same capacity, the production of energy in every turn of the commutator, is considerably weaker than when converters are employed; but with the later arrangement, there is the advantage of reducing the price of installation, using less fragile apparatus and with more perfect action.

The advantages of such an improvement will be better understood by considering the two appended drawings, which show two different methods of carrying out the invention.

In Sheet 1 (Figures 1 and 2), 1, represents a condenser whose pole 20 can be connected by means of an exciter 2, with an electric source connected to the apparatus in pole 14, and its other pole 33 is constantly grounded. Pole 20 of the same condenser can also be connected, by means of an exciter 3, with one of the poles 4 of the primary of the transformer 5, whose other pole is in connection with the pole 33 of the same said condenser 1, in such a way, as to establish an electric communication between the two coatings of said condenser across the said primary. The secondary of the same transformer 5, can be connected by each of its poles, and by means of the exciters 6 and 7 respectively, with the poles 21 of the condensers A, whose other poles 18 are in constant connection with the poles 8 of condensers C, the poles 19 of these same condensers C being constantly grounded. That is to say, the condensers A and C are in connection in "battery".

In order to produce the discharge from this battery, the primary of transformer 25 is employed, one of whose poles is in constant connection with the poles 19 of the condensers C, and its other pole 26 can be put in connection with the poles 21 of the condensers A by means of the exciters 9 and 19. The secondary of the said transformer is in constant connection by one of its poles with one of the poles of the primary of the transformer 30, and its other pole, can be connected with pole 20 of condenser 1, by means of the exciter 11.

The secondary of said transformer 30, is connected with the electric motor 35, and finally by means of wires 36, with the various apparatus which are to use the electric energy produced by this process.

[Price 6d.]

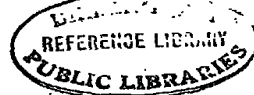

*System for the Generation of Electric Currents.*

In Figure 2, the various abovementioned arrangements are shown together, as they may be placed in actual construction; and in order to produce rapidly the abovementioned connections and interruptions, the exciters 2, 3, 6, 7, 9, 10, 11, suitably isolated, are arranged in conjunction in the interior of the cylinder 38, which is put in motion by the said motor 35, and is still further provided with the handle 37. 5

This arrangement being made, if pole 14 is put in communication with an electric source, and pole 12 with the ground; and if by means of the handle 37, cylinder 38 is rotated so as to cause the exciter 2 to come exactly opposite pole 20 of condenser 1, this condenser will receive an electric charge. Then interrupting communication between poles 20 and 14, by turning pole 13 from its vertical position, and next if by means of the handle 37, the cylinder 38 is caused to rotate with the greatest possible speed in clockwise direction, the following results will be obtained: 10

1. As the exciter 3 comes opposite poles 20 and 4, both coatings of condensers 1, will be in communication through the primary of transformer 5, and in consequence the said condenser will discharge through the said primary. 15

2. In consequence of this discharge producing primary energy, a like energy will be obtained in the secondary of the same transformer 5, which in passing through the exciters 6 and 7, will be stored by the two condensers A. 20

3. These condensers A, supposing to be constructed in exactly equal dimensions with those of the condenser 1, will have nevertheless a capacity equal to half the capacity of condenser 1, since they are connected in battery with the condensers C through poles 18—8. Therefore admitting that the coefficient of transformation in the said transformer 5, is equal to the unit, that is to say, that it has no transformation; the quantity of electricity stored by each of the condensers A, will be almost equal to half the quantity produced by the discharge of the condenser 1, since the loss of transformation must be taken into account. 25

4. In receiving this charge, condensers A induce in their exterior coatings, equal quantities of electricity which will charge condensers C, whose exterior coatings are grounded through pole 12. 30

5. After a half revolution of cylinder 38, connection is established between the interior coatings of condensers A, and the exterior coatings of condensers C, through the exciters 9 and 10, and the primary of transformer 25. That is to say the discharge of battery A—C will be produced through the said primary. 35

6. As a result of this discharge all the electricity stored by the two condensers A, will pass through the same said primary, and although this quantity of electricity is equal to that produced by the discharge from condenser 1, minus the loss caused by transformation; the energy induced by this discharge, is double the amount produced by the discharge of condenser 1, through the primary of transformer 5, because the electric pressure now occasioned by the connection of the condensers A and C in battery, is double that produced by the discharge of the single condenser 1. 40

Under these conditions, part of the energy produced by the secondary of the transformer 25, can be sent back through exciter 11 to produce a fresh charge in condenser 1, so as to establish the original conditions once more, without having any further need of an external aid. The remainder of the said energy passing through the primary of transformer 30, will produce in the secondary of the same, fresh induced currents, part of which can be used to operate the motor 35, and the rest can be employed at will for any other purpose, outside the automatic operation of the machine under description. That is to say the original conditions being thus reestablished at every turn of the cylinder 38, the same phenomena will be produced indefinitely, as many times as the revolutions of the said cylinder are repeated, without having recourse to any exterior aid. 50

In fine by this arrangement even without increasing the quantity of electricity by means of the electrical oscillations, an increase in 55

*System for the Generation of Electric Currents.*

energy can be effected at every turn of the cylinder 38, by means of the increase in voltage produced by the connection of condensers A—C in battery. That is to say the energy of the exterior coatings of condensers A produced during the charging of its collectors, is employed to increase the energy of the collectors of the same condensers A, whether acting under pressure as in the present instance, or under its own quantity of electricity, as has been explained in the original description of this process, and as will be seen in the following case, illustrated by the Sheet 2, in which:

10 In the Figure 3, the condensers 1, can be connected by their poles 20, by means of an exciter 13, with an electric source connected to the apparatus in 14, and their other poles 33, are constantly grounded. The said poles 20, of the same condensers 1, can again be connected by means of exciter 3, with one of the poles 4 of the primary of transformer 5, whose other pole is connected  
15 with pole 33 of the said condensers 1, so as to establish connection between their two coatings through the said primary. The secondary of the same transformer 5, may be connected by each of its poles, and by means of the exciters 6 and 7 respectively, with the poles 21 of condensers A, whose other poles 18, are in connection through the exciters 15 and 16 respectively, with the poles 8  
20 of condensers C, the poles 19 of these same condensers C being grounded. That is to say the undermentioned condensers A—C, are put in this manner temporarily in connection in battery.

After a third of a revolution, the poles shown by the cylinder of Figure 4, will exactly face the line of the poles of the condensers of the machine shown  
25 by Figure 3, and in order to utilise the electric charge of the said condensers C to recharge the same condensers A, the primary of the transformer 2 is used; one of whose poles is in constant connection with the poles 19 of the condensers C, and the other pole 9 can be connected with poles 8 of the same condensers C, by means of the exciter 17 (Figure 4), so as to establish the electric communication between the two coatings of the said condensers through the said primary.  
30 The secondary of the same transformer 2 can now be connected by each of its poles, and by means of the exciters 22 and 23 respectively, with the poles 21 of condensers A. Poles 18 of the same condensers A, are now connected through the exciters 24 and 25 respectively with poles 20 of the condensers 1. That  
35 is to say by these means the said condensers A, are now connected in battery with condensers 1.

After two thirds of a revolution the poles shown in the cylinder of Figure 5, will come exactly opposite the line of the poles of the condensers of Figure 3, and in order to produce the discharge of condensers A, the primary of trans-  
40 former 25 is used, one of whose poles 26 is connected by means of the exciter 27, with poles 21 of the said condensers, and its other pole 28 is in like manner connected through exciter 29, with the poles 18 of the same condensers A. That is to say the two coatings are in this way connected through the said primary. The secondary of the said transformer 25, is in constant connection  
45 by one of its poles with one of the poles of the primary of transformer 30, and its other pole 31, may be connected with poles 20 of condensers 1, by means of the exciter 11.

The secondary of transformer 30, is in connection with the electric motor 35, and finally by means of the wires 36 with the apparatus which are to use the  
50 power produced by this process.

The various undermentioned exciters suitably isolated, are arranged in combination as in the preceding case, in the interior of the cylinder commutator 38, and it is only in order to show clearly the different connections at each third of a revolution, that the said exciters have been separated into three different  
55 cylinders.

The arrangement being made in this manner, if cylinder 38 is turned by means of handle 37, so as to cause the dotted line M—N marked on the same

*System for the Generation of Electric Currents.*

cylinder, to come exactly opposite the line of the poles of the condensers, and if pole 14 is put in connection with one electric source, and pole 12 with the ground, condensers 1 will receive an electric charge. Then interrupting communication between poles 20 and 14 by turning exciter 13 from its vertical position, and if by means of handle 37, cylinder 38 is made to rotate with the greatest possible speed in clockwise direction, the following results will be obtained:—

1. As exciter 3 comes opposite poles 20 and 4, the two coatings of condensers 1 will be in connection through the primary of transformer 5, and as a result the said condensers will discharge through the said primary. 10
2. In consequence of this discharge producing primary energy, a like energy will be induced in the secondary of the same transformer 5, which passing through exciters 6, 7, will be stored by the two condensers A. 10
3. The condensers A in receiving this charge, will induce an equal amount of electricity in their exterior coatings, which passing through exciters 15 and 16 will charge condensers C whose exterior coatings are grounded. 15
4. After a third of a revolution of cylinder 38, connection is established between the interior and exterior coatings of condensers C, through the exciter 17 and the primary of transformer 2. That is to say, the discharge of the said condensers will be produced through the said primary. 20
5. As a consequence of this discharge producing primary energy, a like energy will be set up in the secondary of the same transformer 2, producing an electric current, which passing through the exciters 22 and 23, will recharge the condensers A, increasing in this manner its quantity of electricity, exactly in the same way as was explained in the original description of this process, but without having any further need of converters. 25
6. Condensers A receiving this fresh charge, will induce fresh quantities of electricity in their exterior coatings, which passing this time through exciters 24 and 25, will be stored by condensers 1, which after having been entirely discharged will receive a fresh charge. 30
7. After two thirds of a revolution, connection is established between the two coatings of condensers A, through exciters 27, 29, and the primary of transformer 25. That is to say, the total discharge of the said condensers will be produced through the said primary. 30
8. As a result of this discharge producing an electric current through the said primary of transformer 25, induced currents will be set up in the secondary of the same transformer, part of which passing through exciter 11, will be stored by the two condensers 1, so as to re-establish its original charge without having recourse to any external aid. The remainder of said currents passing through the primary of transformer 30, will still produce in the secondary of the same, fresh induced currents, part of which can be used to operate the motor 35, and the rest can be employed at will for any other purpose, outside the automatic operation of the machine under description. 35

In fine, having condensers with suitable capacities, and transformers with the coefficient of transformation duly regulated, after two thirds of a revolution of cylinder 38, condensers 1 will receive the exact amount of electricity necessary to reestablish the original conditions, and when the entire revolution is accomplished, the same operations can still be reproduced exactly as before, thus arriving automatically at the same results as often as the revolutions of the said cylinder 38 are made. 45

The advantages of these new arrangements and its method of operation, will now be easily understood by all those skilled in these matters, and while I have described said improvements showing two different cases, that I considered preferable for illustration purposes, it is obvious to state that by practice, adequate changes may be made producing several other arrangements, that would be useless to describe specifically, but that will be particularly pointed out in the following claims. 55

---

*System for the Generation of Electric Currents.*

---

Having now particularly described and ascertained the nature of my said invention and in what manner the same is to be performed, I declare that what I claim is:—

In a system for the generation of electric currents; disposed in combination:

5 1. Mechanisms or suitable means producing the charge of one or more condensers; suitable mechanisms for the utilisation of the energy induced by the exterior coating of the said condensers, produced during the charging of their collectors or interior coatings; mechanisms or suitable means for increasing the power of the said collectors, by means of the abovementioned energy produced  
10 by the said exterior coatings; and suitable means for discharging the said collectors, and for the application in whole or part of the energy produced by this discharge, in the successive reproduction of the said operations, so as to obtain a continually increasing quantity of electric energy, or to maintain a constant definite production.

5 2. Mechanisms or suitable means for charging one or more condensers whose exterior coatings are grounded; one or more transformers placed so as to receive the discharge of the said condensers through the primary of the same transformers; suitable means for the collection of the secondary currents produced  
10 in the transformers as a consequence of the said discharge, and for its use in the fresh charging of new condensers; suitable means for the utilisation of the energy induced in the exterior coatings of the latter condensers, so as to increase the energy of their own collectors; suitable means for discharging the same  
15 collectors, and for the application in whole or part of the energy produced by this discharge, in the successive repetition of the said operations, so as to obtain a continually increasing sum of electric energy, or to maintain a constant  
20 definite production; and finally means disposed so as to create and interrupt effectively the electric connections between the different abovementioned apparatus.

3. Mechanisms or apparatus arranged, connected and working substantially  
10 in the manner described in connection with the appended drawings, and for the purpose shown.

Dated the 13th day of April, 1915.

CARLOS F. BENITEZ.

Fig. 1.

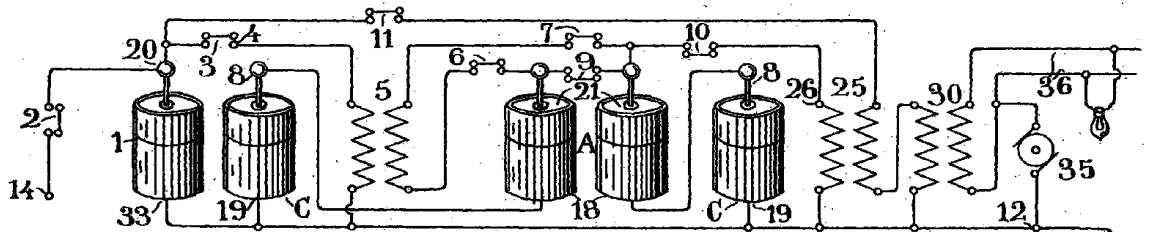
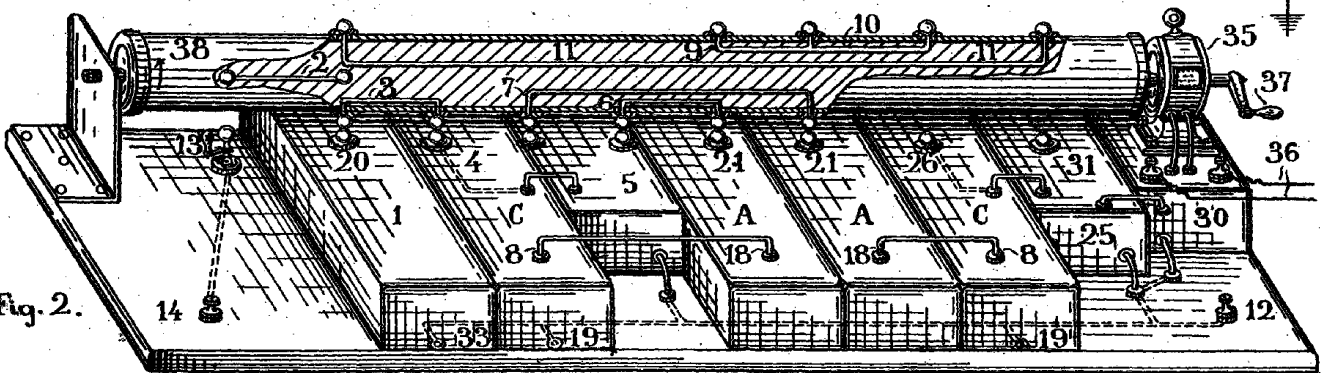
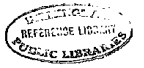

Fig. 2.



[This Drawing is a full-size reproduction of the Original.]





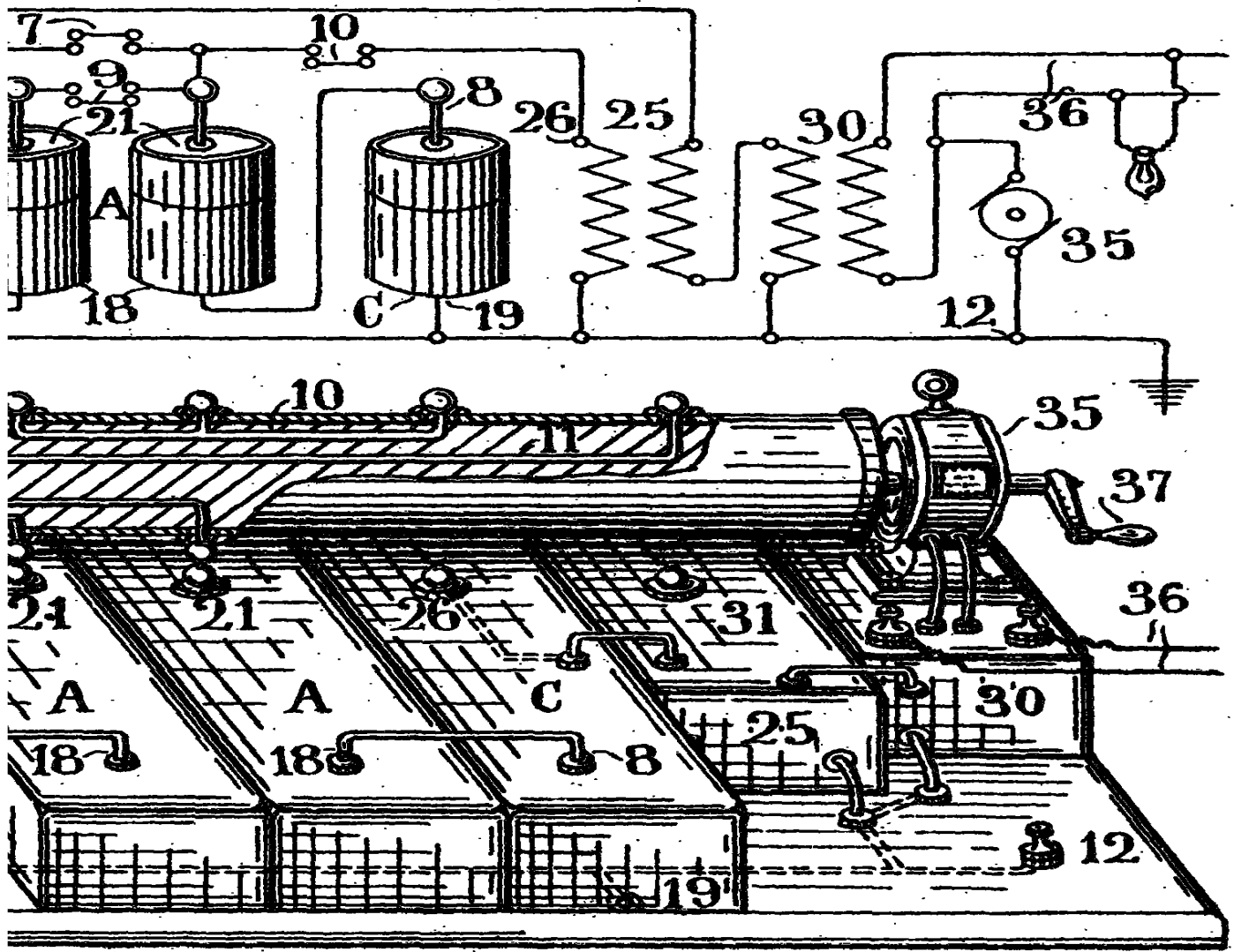

BRITISH  
REFERENCE LIBRARY  
PUBLIC LIBRARIES



[This Drawing is a full-size reproduction of the Original.]



Fig. 5.



Fig. 4.

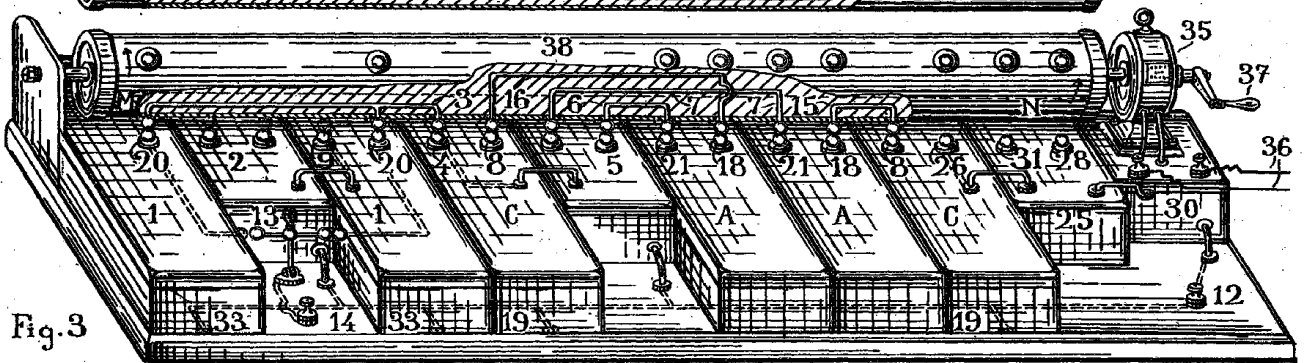
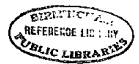

Fig. 3



[This Drawing is a full-size reproduction of the Original.]

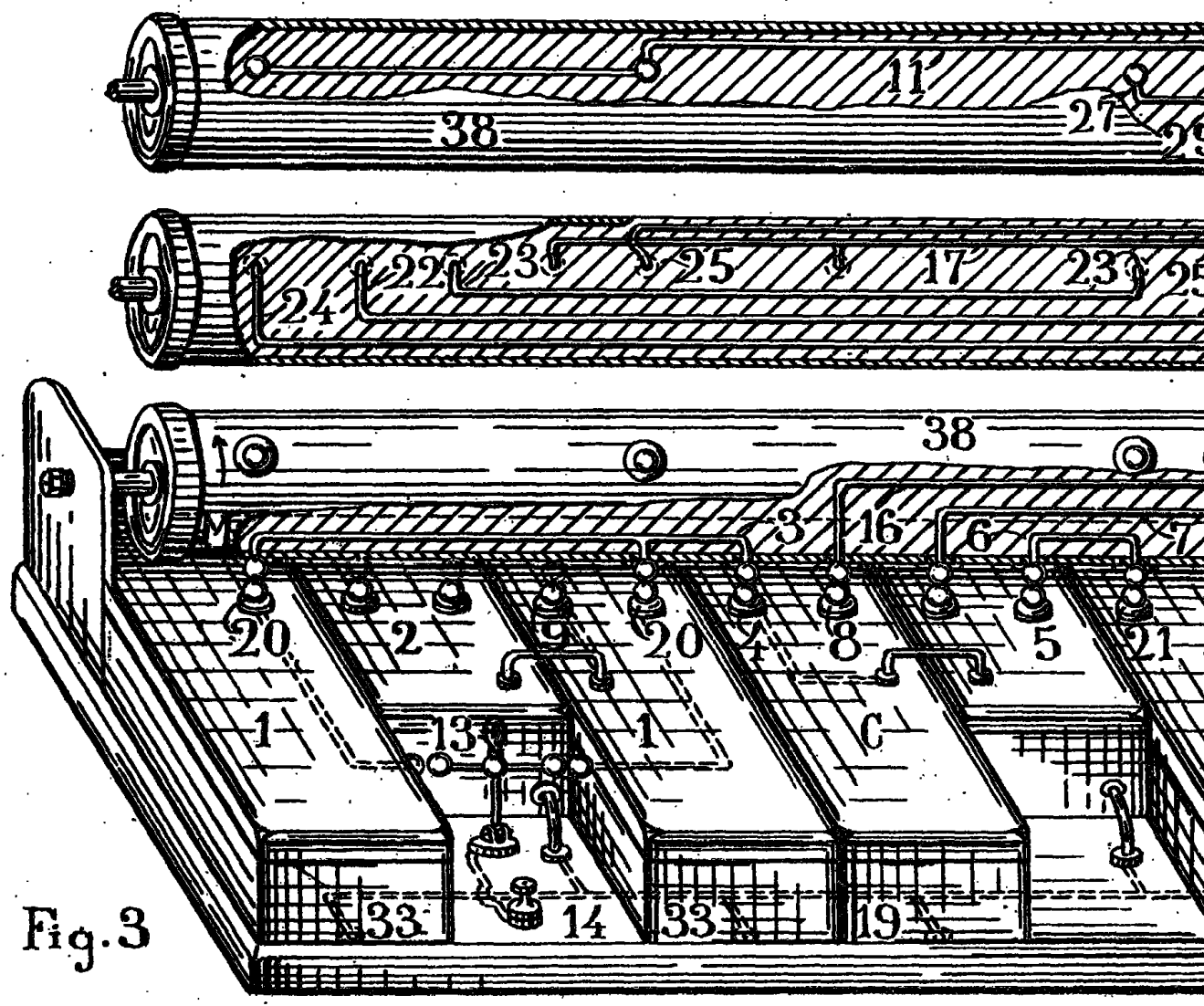

Fig. 3

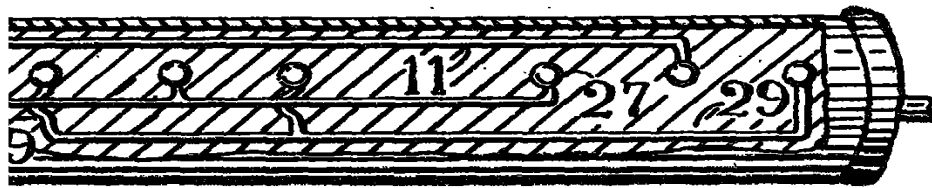

Fig. 5.

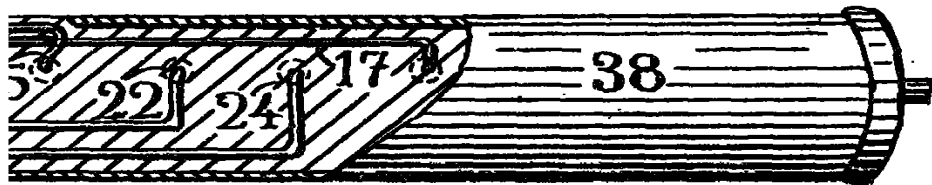
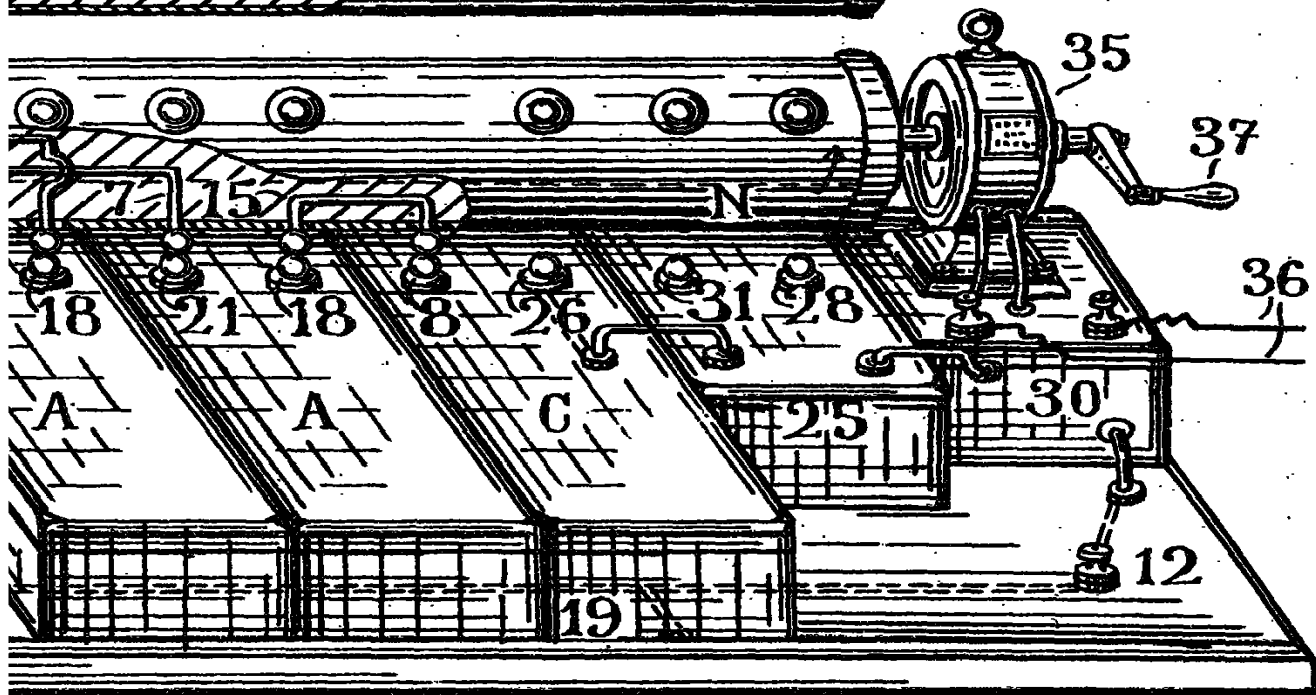

Fig. 4.



BRITISH  
REFERENCE LIBRARY  
PUBLIC LIBRARIES